

# MagicCylinder® EquiFlow

Change colors quick and easy with EquiFlow technology!



## Systems for automatic powder coating

Benefit from the most advanced powder coating technology:

- Precise process control, leading-edge electrostatic system and the most advanced booth design
- Excellent coating conditions inside the booth as well as at pre- and post-touchup stations
- Quick color changes without entering the booth

**Gema**

The Global Leader in  
Powder Coating Technology

# The perfect air distribution and quick color changes



## The quickest color change

MagicCylinder stands for the quickest color change. The circular design of the booth in combination with the EquiFlow exhaust technology makes the MagicCylinder the top-quality choice among quick color change systems.

## Ideal coating conditions and quick color changes

Extremely uniform airflow creates the ideal conditions for perfect control of the powder application process producing excellent coating results. The use of non-conductive plastic materials for the booth and its self-cleaning floor prevent powder accumulations.

## EquiFlow technology for intelligent air distribution

Air extraction is concentrated where it is needed most, at the booth's entry and exit. This prevents powder from escaping into the environment, and creates an ideal airflow at the pre- and post-touchup stations. This results in a perfect balance between the powerful air extraction at the manual coating area and gentle airflow in the automatic section.

## EquiFlow technology

ensures a uniform flow of air in the automatic coating zone and optimal air extraction at the pre- and post-touchup stations.

## Air flow simulation

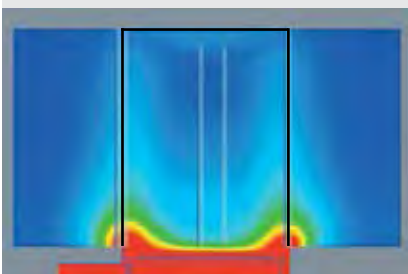

## The MagicCylinder System with EquiFlow technology is designed to achieve many contrasting goals:

- Create an optimal environment for the electrostatic powder application process
- Avoid accumulation of powder
- Allow quick contamination free color changes
- Provide powerful air extraction to prevent powder from escaping and maintain safe powder concentration

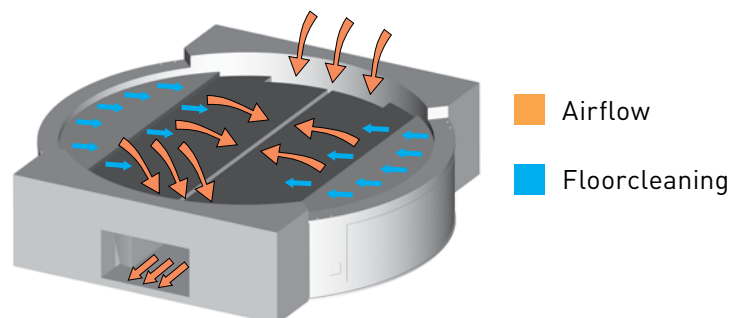

# Space saving layout – ideal for new installations and upgrades

## Short installation time

Most of the system components are delivered preassembled so the system can be installed very quickly. It can be easily integrated into existing installations with minimal downtime.

## Robust, low maintenance costs

The solid booth construction without any moving parts ensures a long service life with extremely low maintenance costs. The booth floor is easily accessible for maintenance and control.

## Efficient, user-friendly layout

All system components are optimally matched based on our extensive worldwide experience. This means that the operator can easily and quickly access all key system elements during normal operation as well as during the color change process and for maintenance.



## Space saving design for an ergonomic workplace

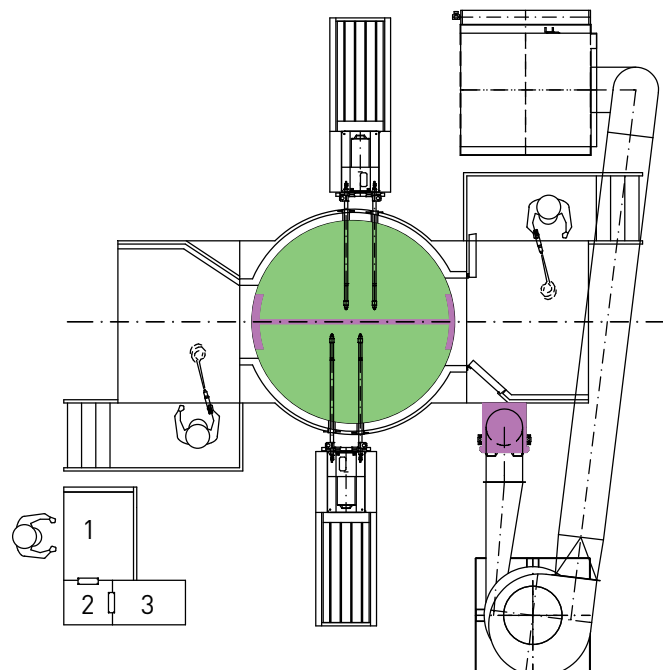

### OptiCenter

- 1 - Powder handling
- 2 - Electrostatic control unit
- 3 - System control



1



2



3



5

1

4

2

1

### A completely different kind of sandwich

The MagicCylinder EquiFlow features a sandwich-wall booth construction, minimizing powder accumulation on the booth walls. The booth floor is equipped with an automatic cleaning system to prevent unused powder from collecting.

2

### Controlling the coating

Are powder savings important? Are repeatable coating results and operator comfort a priority? The versatile CM30, MagicControl system with Touch Panel, provides continual access to all parameters of the coating process.

3

### Applying the powder where and when required

The MagicCylinder EquiFlow powder circuit provides continuous and consistent powder feed with minimal wear on parts. The OptiCenter, injectors, powder pumps and recovery system are all optimally matched to each other and ensure superior performance. The fresh powder feed and sieving solutions are integrated into the system and designed to meet the application requirements.

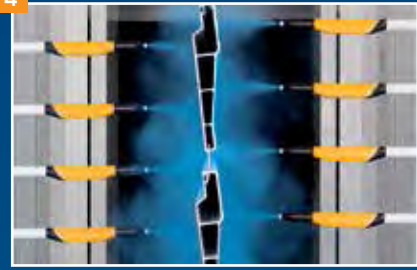

4

### The heart of the powder coating

High transfer efficiency, minimal powder output and uniform power application: powder guns are the heart of the powder coating process. A design with minimal wear components is a prerequisite. The excellent ergonomics and the lightweight design of the OptiSelect® guarantee fatigue-free manual coating.

5

### For a good atmosphere

Our cyclones and filter units offer high-performance to ensure that the MagicCylinder EquiFlow system meets all safety regulations. Gema cyclone and filtration units deliver high separation efficiency which yields excellent recovery performance.

6

### Coating in every direction

A uniform distribution of the powder film is a necessary condition for achieving high-quality results at the lowest powder consumption rate. Gema's reciprocators and positioners cover all motion profiles, such as horizontal, vertical, internal coating or rotary axis movement.





# OptiCenter: Rapid cleaning and superb coating results



## Efficient powder management

The core of this new powder center is the OptiSpeeder II. This unique container concept prevents the loss of powder associated with traditional open fluidization devices. Control of the entire powder circuit is done fully automatically and precisely. The result is extremely low powder consumption and excellent coating results.



## Improved coating quality

The OptiSpeeder II is equipped with an automatic fresh powder supply and a powder-level control system that ensures a constant amount of powder in the container. The suction channels for the injectors are considerably shorter than in conventional powder centers. These features translate into an even more uniform powder flow and improved coating results.

## Automated color change

The overall design of the OptiCenter allows extremely quick color changes and all functions are integrated into the system.

## Closed and efficient powder circuit

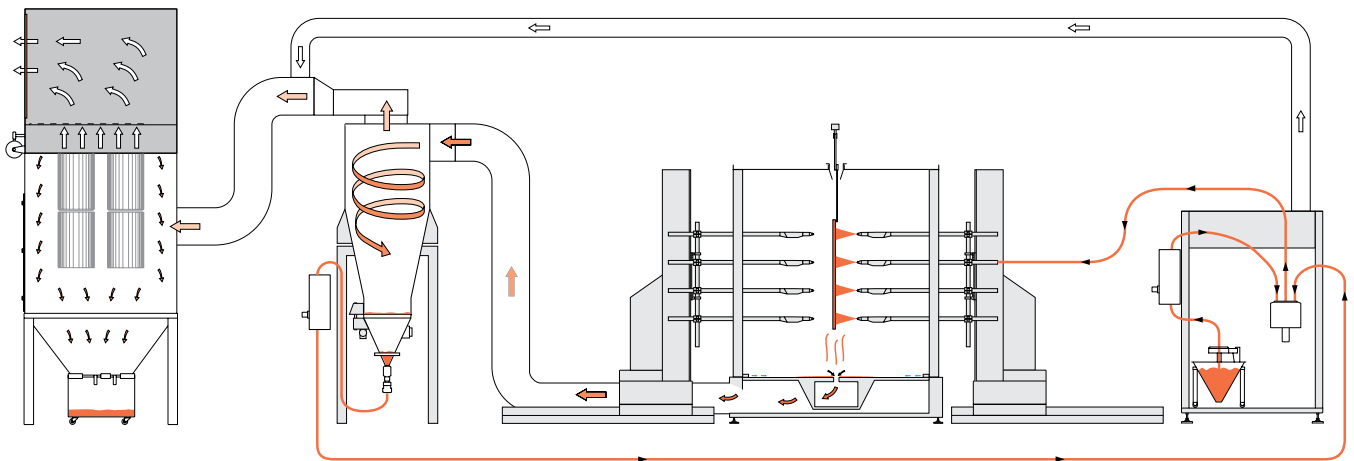

# OptiFlex: the core of the electrostatic coating process

## OptiGun® - Designed for quick color changes

The OptiGun automatic powder gun is compact and easy to maintain. During color changes, the gun is rapidly cleaned and ready to be used again. All the components are easy to clean and designed for low wear.



## Remote control on the OptiSelect® manual gun

Keep eyes on the work piece, not on the control unit! With the remote control on the back of the OptiSelect, the right program can be selected, even if the control module is out of reach.

## OptiStar® - All parameters at a glance

With the OptiStar and MagicControl® control modules you have precise control of all coating parameters. Clear symbols, easy programming and perfect reproduction of coating results contribute to significantly increased coating quality.



## The most advanced powder application technology

The powder guns are perfectly matched to the OptiStar control unit and offer the highest degree of coating efficiency and user-friendliness.

- High transfer efficiency with every type of powder due to the 100 kV high-performance cascade
- Constant powder delivery and continuous powder charging for a uniform coating thickness
- Patented Digital Valve Control (DVC) for accurate powder delivery control
- The Precision Charge Control Mode (PCC) adjusts the current flow even in the lowest amperage range (0-10  $\mu$ A) with the highest levels of precision. Therefore overcharging of sensitive powder, such as metallic and special effect powder, is eliminated
- A display screen ensures easy access to pre-set and customized coating programs
- Reduced maintenance costs through wear-resistant design

## SuperCorona®

The optional SuperCorona attachment neutralizes free ions, avoids an orange peel texture on higher film builds, and improves the surface appearance.

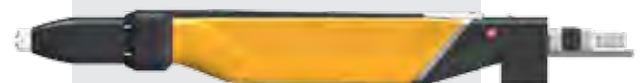

OptiGun GA03



reddot award 2014  
winner

Gema

## Your global partner for high quality powder coating

Take advantage of our expertise and experience from more than 40 years of electrostatic powder coating applications. From simple manual coating to fully automated powder coating, we offer solutions that meet the demands and requirements of customers around the world in a wide range of industrial sectors. A global service network ensures you always get professional support, at any time and any place!

We make our customer's products more durable and attractive. Our finishing experts create the technologies, processes and materials that regularly set the standard for the industry.



**Gema**

The Global Leader in  
Powder Coating Technology

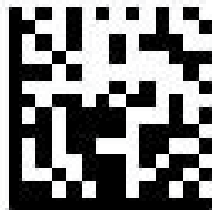

[gemapowdercoating.com](http://gemapowdercoating.com)

Phone: 800-628-0601

Gema reserves the right to make technical modifications without prior notice. Illustrations in this leaflet may contain optional equipment and do not necessarily show the standard configuration. OptiCenter, MagicCenter, OptiSpeeder, MagicCompact, MagicCylinder, OptiFlex, OptiStar, OptiGun, OptiSelect, MagicControl, OptiControl and OptiFlow are trademarks of Gema.



Member of  
The Powder Coating  
Institute

